



FGA25N120ANTD/FGA25N120ANTD_F109

1200V NPT Trench IGBT

Features

- NPT Trench Technology, Positive temperature coefficient
- Low saturation voltage: $V_{CE(sat), typ} = 2.0V$
@ $I_C = 25A$ and $T_C = 25^\circ C$
- Low switching loss: $E_{off, typ} = 0.96mJ$
@ $I_C = 25A$ and $T_C = 25^\circ C$
- Extremely enhanced avalanche capability

Description

Using Fairchild's proprietary trench design and advanced NPT technology, the 1200V NPT IGBT offers superior conduction and switching performances, high avalanche ruggedness and easy parallel operation.

This device is well suited for the resonant or soft switching application such as induction heating, microwave oven, etc.

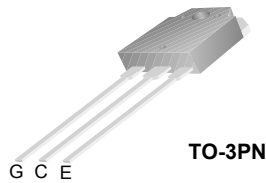

TO-3PN

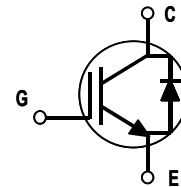

Absolute Maximum Ratings

| Symbol | Description | FGA25N120ANTD | Units |
|-----------|---|-----------------------|------------|
| V_{CES} | Collector-Emitter Voltage | 1200 | V |
| V_{GES} | Gate-Emitter Voltage | ± 20 | V |
| I_C | Collector Current | @ $T_C = 25^\circ C$ | 50 |
| | Collector Current | @ $T_C = 100^\circ C$ | 25 |
| I_{CM} | Pulsed Collector Current (Note 1) | 90 | A |
| I_F | Diode Continuous Forward Current | @ $T_C = 100^\circ C$ | 25 |
| I_{FM} | Diode Maximum Forward Current | 150 | A |
| P_D | Maximum Power Dissipation | @ $T_C = 25^\circ C$ | 312 |
| | Maximum Power Dissipation | @ $T_C = 100^\circ C$ | 125 |
| T_J | Operating Junction Temperature | -55 to +150 | $^\circ C$ |
| T_{stg} | Storage Temperature Range | -55 to +150 | $^\circ C$ |
| T_L | Maximum Lead Temp. for soldering Purposes, 1/8" from case for 5 seconds | 300 | $^\circ C$ |

Thermal Characteristics

| Symbol | Parameter | Typ. | Max. | Units |
|-----------------|--|------|------|--------------|
| $R_{\theta JC}$ | Thermal Resistance, Junction-to-Case for IGBT | -- | 0.4 | $^\circ C/W$ |
| $R_{\theta JC}$ | Thermal Resistance, Junction-to-Case for Diode | -- | 2.0 | $^\circ C/W$ |
| $R_{\theta JA}$ | Thermal Resistance, Junction-to-Ambient | -- | 40 | $^\circ C/W$ |

FGA25N120ANTD/FGA25N120ANTD_F109 1200V NPT Trench IGBT

Package Marking and Ordering Information

| Device Marking | Device | Package | Reel Size | Tape Width | Quantity |
|----------------|---------------|---------|-----------|------------|----------|
| FGA25N120ANTD | FGA25N120ANTD | TO-3P | -- | -- | 30 |

Electrical Characteristics of the IGBT T_C = 25°C unless otherwise noted

| Symbol | Parameter | Test Conditions | Min. | Typ. | Max. | Units |
|----------------------------------|---|--|------|------|-------|-------|
| Off Characteristics | | | | | | |
| I _{CES} | Collector Cut-Off Current | V _{CE} = V _{CES} , V _{GE} = 0V | -- | -- | 3 | mA |
| I _{GES} | G-E Leakage Current | V _{GE} = V _{GES} , V _{CE} = 0V | -- | -- | ± 250 | nA |
| On Characteristics | | | | | | |
| V _{GE(th)} | G-E Threshold Voltage | I _C = 25mA, V _{CE} = V _{GE} | 3.5 | 5.5 | 7.5 | V |
| V _{CE(sat)} | Collector to Emitter Saturation Voltage | I _C = 25A, V _{GE} = 15V | -- | 2.0 | 2.5 | V |
| | | I _C = 25A, V _{GE} = 15V, T _C = 125°C | -- | 2.15 | -- | V |
| | | I _C = 50A, V _{GE} = 15V | -- | 2.65 | -- | V |
| Dynamic Characteristics | | | | | | |
| C _{ies} | Input Capacitance | V _{CE} = 30V, V _{GE} = 0V, f = 1MHz | -- | 3700 | -- | pF |
| C _{oes} | Output Capacitance | | -- | 130 | -- | pF |
| C _{res} | Reverse Transfer Capacitance | | -- | 80 | -- | pF |
| Switching Characteristics | | | | | | |
| t _{d(on)} | Turn-On Delay Time | V _{CC} = 600 V, I _C = 25A, R _G = 10Ω, V _{GE} = 15V, Inductive Load, T _C = 25°C | -- | 50 | -- | ns |
| t _r | Rise Time | | -- | 60 | 90 | ns |
| t _{d(off)} | Turn-Off Delay Time | | -- | 190 | -- | ns |
| t _f | Fall Time | | -- | 100 | 180 | ns |
| E _{on} | Turn-On Switching Loss | | -- | 4.1 | 6.2 | mJ |
| E _{off} | Turn-Off Switching Loss | | -- | 0.96 | 1.5 | mJ |
| E _{ts} | Total Switching Loss | | -- | 5.06 | 7.7 | mJ |
| t _{d(on)} | Turn-On Delay Time | V _{CC} = 600 V, I _C = 25A, R _G = 10Ω, V _{GE} = 15V, Inductive Load, T _C = 125°C | -- | 50 | -- | ns |
| t _r | Rise Time | | -- | 60 | -- | ns |
| t _{d(off)} | Turn-Off Delay Time | | -- | 200 | -- | ns |
| t _f | Fall Time | | -- | 154 | -- | ns |
| E _{on} | Turn-On Switching Loss | | -- | 4.3 | 6.9 | mJ |
| E _{off} | Turn-Off Switching Loss | | -- | 1.5 | 2.4 | mJ |
| E _{ts} | Total Switching Loss | | -- | 5.8 | 9.3 | mJ |
| Q _g | Total Gate Charge | V _{CE} = 600 V, I _C = 25A, V _{GE} = 15V | -- | 200 | 300 | nC |
| Q _{ge} | Gate-Emitter Charge | | -- | 15 | 23 | nC |
| Q _{gc} | Gate-Collector Charge | | -- | 100 | 150 | nC |

Notes:

(1) Repetitive rating: Pulse width limited by max. junction temperature

Electrical Characteristics of DIODE $T_C = 25^\circ\text{C}$ unless otherwise noted

| Symbol | Parameter | Test Conditions | Min. | Typ. | Max. | Units | |
|----------|-------------------------------------|--|---------------------------|------|------|-------|----|
| V_{FM} | Diode Forward Voltage | $I_F = 25\text{A}$ | $T_C = 25^\circ\text{C}$ | -- | 2.0 | 3.0 | V |
| | | | $T_C = 125^\circ\text{C}$ | -- | 2.1 | -- | |
| t_{rr} | Diode Reverse Recovery Time | $I_F = 25\text{A}$ $di/dt = 200\text{ A}/\mu\text{s}$ | $T_C = 25^\circ\text{C}$ | -- | 235 | 350 | ns |
| | | | $T_C = 125^\circ\text{C}$ | -- | 300 | -- | |
| I_{rr} | Diode Peak Reverse Recovery Current | | $T_C = 25^\circ\text{C}$ | -- | 27 | 40 | A |
| | | | $T_C = 125^\circ\text{C}$ | -- | 31 | -- | |
| Q_{rr} | Diode Reverse Recovery Charge | | $T_C = 25^\circ\text{C}$ | -- | 3130 | 4700 | nC |
| | | | $T_C = 125^\circ\text{C}$ | -- | 4650 | -- | |

Typical Performance Characteristics

Figure 1. Typical Output Characteristics

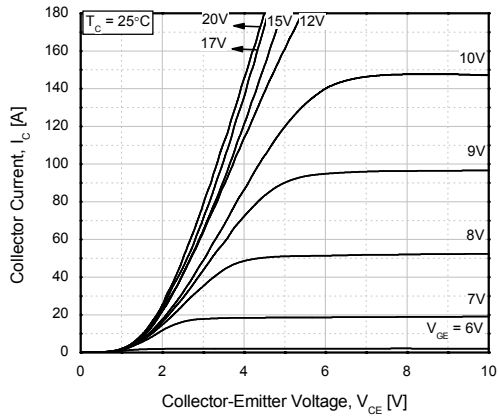

Figure 2. Typical Saturation Voltage Characteristics

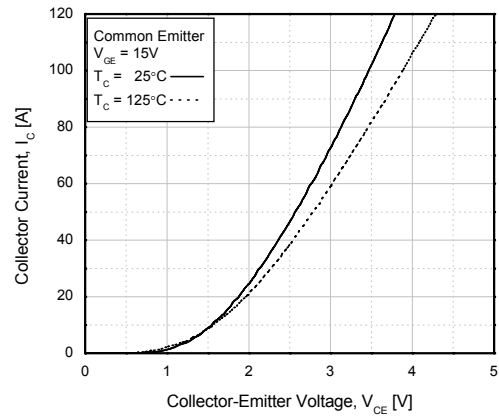

Figure 3. Saturation Voltage vs. Case Temperature at Variant Current Level

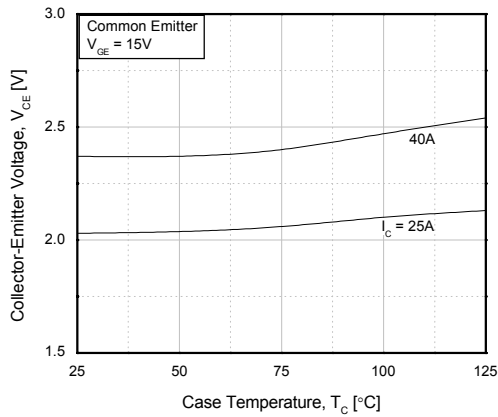

Figure 4. Saturation Voltage vs. V_GE

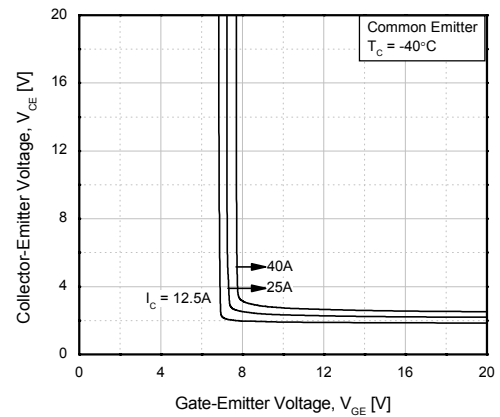

Figure 5. Saturation Voltage vs. V_GE

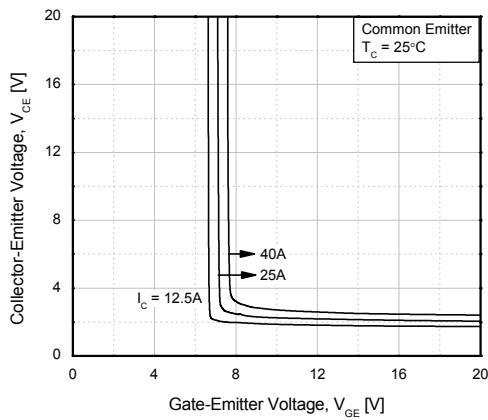
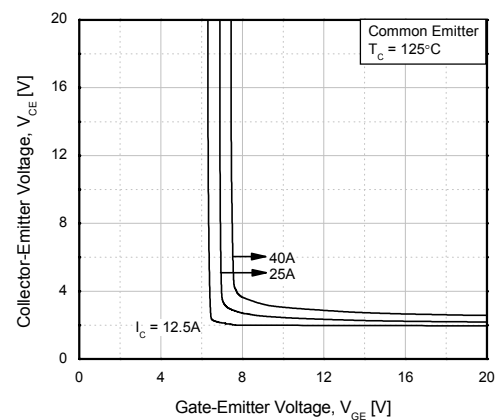

Figure 6. Saturation Voltage vs. V_GE



Typical Performance Characteristics (Continued)

Figure 7. Capacitance Characteristics

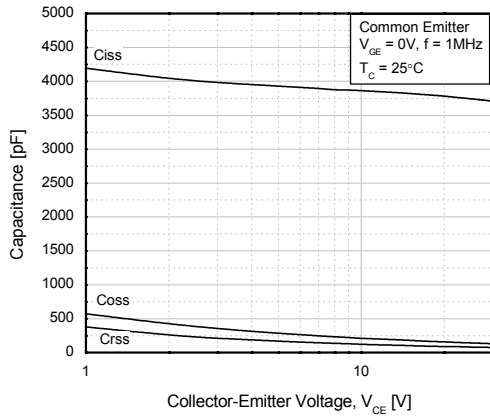

Figure 8. Turn-On Characteristics vs. Gate Resistance

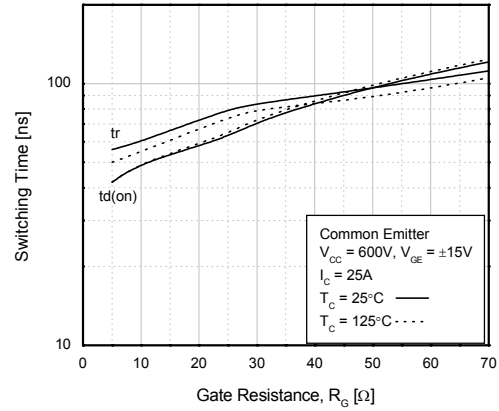

Figure 9. Turn-Off Characteristics vs. Gate Resistance

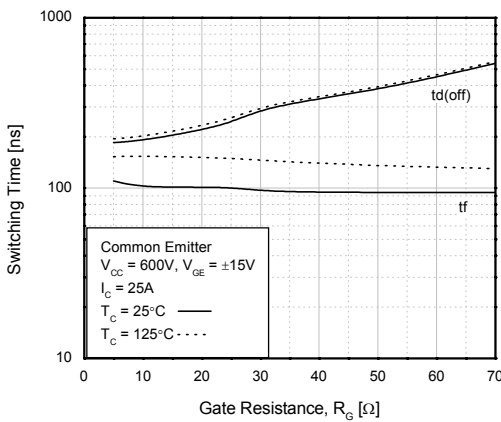

Figure 10. Switching Loss vs. Gate Resistance

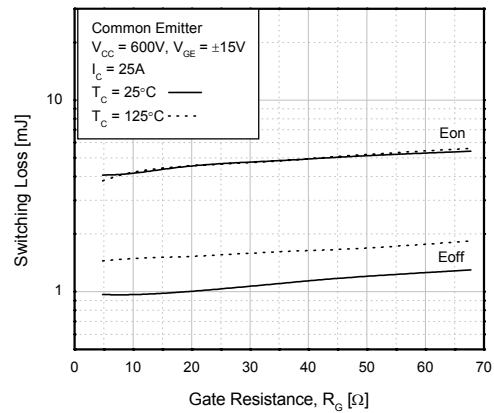

Figure 11. Turn-On Characteristics vs. Collector Current

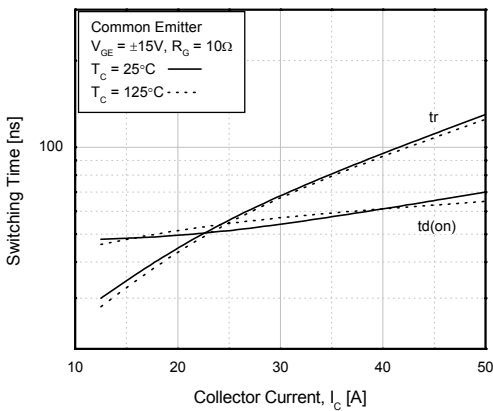
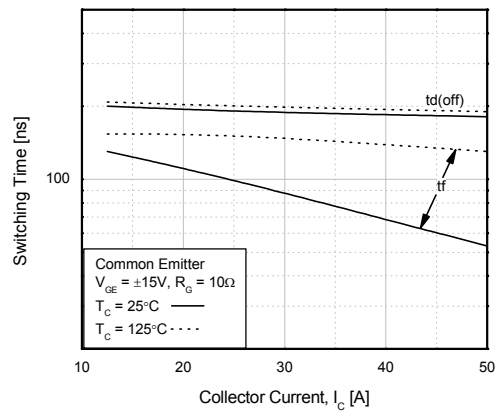

Figure 12. Turn-Off Characteristics vs. Collector Current



Typical Performance Characteristics (Continued)

Figure 13. Switching Loss vs. Collector Current

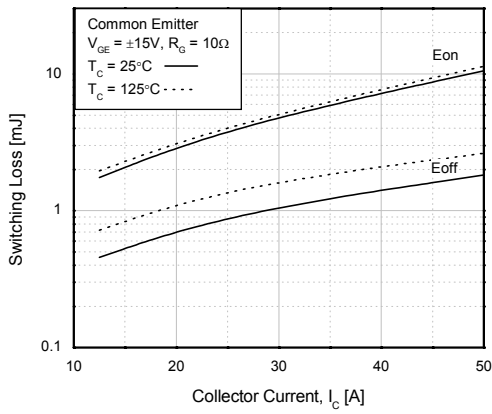

Figure 14. Gate Charge Characteristics

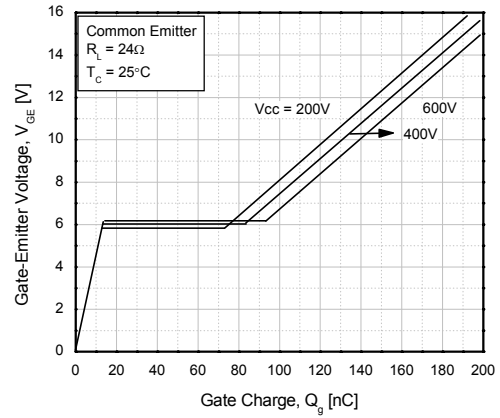

Figure 15. SOA Characteristics

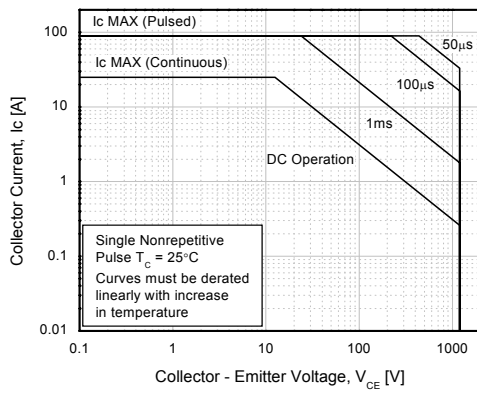

Figure 16. Turn-Off SOA

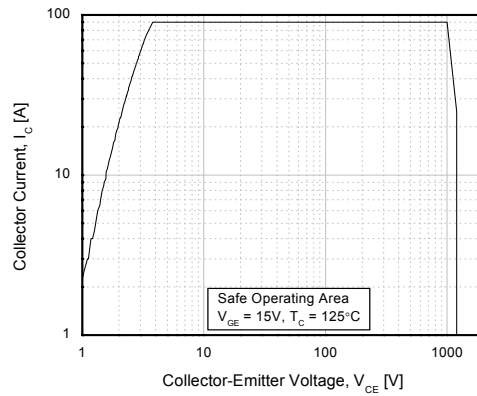
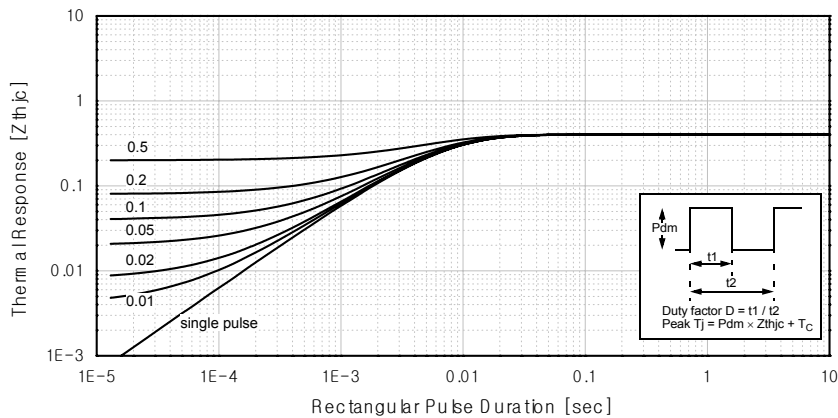

Figure 17. Transient Thermal Impedance of IGBT



Typical Performance Characteristics (Continued)

Figure 18. Forward Characteristics

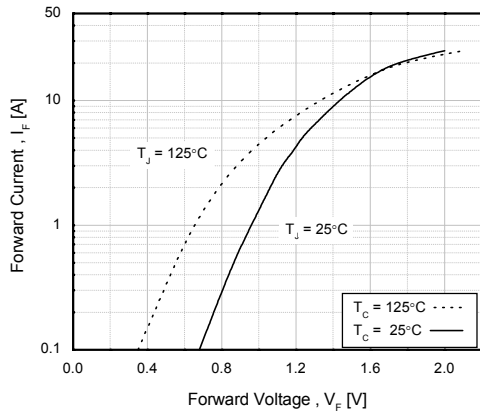

Figure 19. Reverse Recovery Current

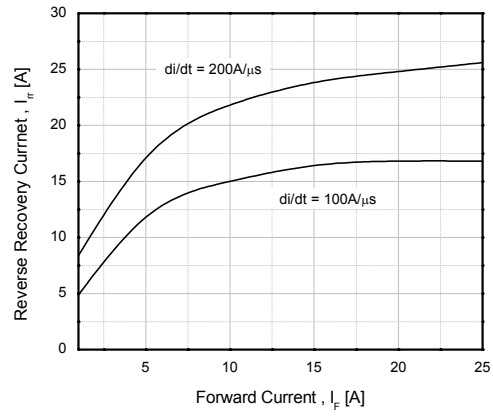

Figure 20. Stored Charge

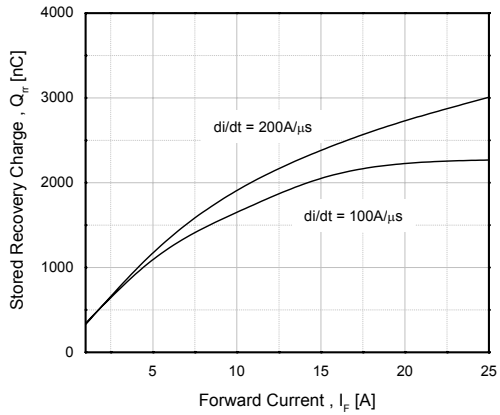
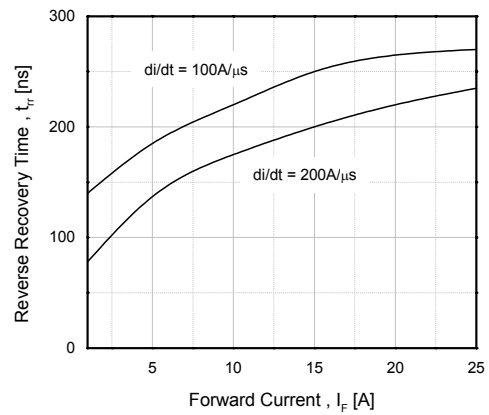
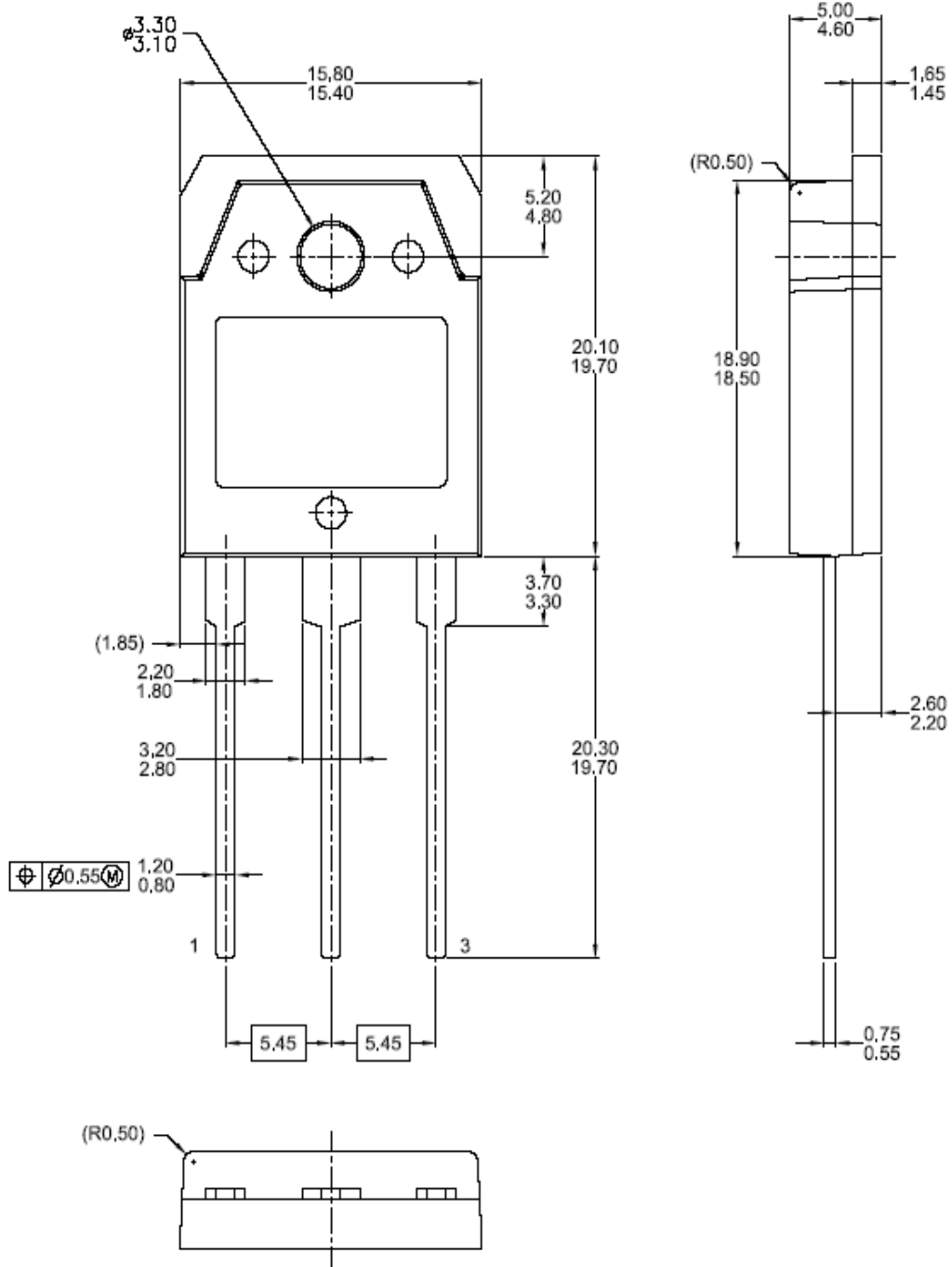

Figure 21. Reverse Recovery Time



Mechanical Dimensions (continued)

TO-3PN



Dimensions in Millimeters

TRADEMARKS

The following are registered and unregistered trademarks Fairchild Semiconductor owns or is authorized to use and is not intended to be an exhaustive list of all such trademarks.

| | | | | |
|--------------------------------------|---------------------|---------------------|------------------|-----------|
| ACEx™ | FACT Quiet Series™ | OCX™ | SILENT SWITCHER® | UniFET™ |
| ActiveArray™ | GlobalOptoisolator™ | OCXPro™ | SMART START™ | UltraFET® |
| Bottomless™ | GTO™ | OPTOLOGIC® | SPM™ | VCX™ |
| Build it Now™ | HiSeC™ | OPTOPLANAR™ | Stealth™ | Wire™ |
| CoolFET™ | I ² C™ | PACMAN™ | SuperFET™ | |
| CROSSVOLT™ | i-Lo™ | POP™ | SuperSOT™-3 | |
| DOME™ | ImpliedDisconnect™ | Power247™ | SuperSOT™-6 | |
| EcoSPARK™ | IntelliMAX™ | PowerEdge™ | SuperSOT™-8 | |
| E ² CMOS™ | ISOPLANAR™ | PowerSaver™ | SyncFET™ | |
| EnSigna™ | LittleFET™ | PowerTrench® | TCM™ | |
| FACT™ | MICROCOUPLER™ | QFET® | TinyBoost™ | |
| FAST® | MicroFET™ | QST™ | TinyBuck™ | |
| FAST _r ™ | MicroPak™ | QT Optoelectronics™ | TinyPWM™ | |
| FPS™ | MICROWIRE™ | Quiet Series™ | TinyPower™ | |
| FRFET™ | MSX™ | RapidConfigure™ | TinyLogic® | |
| | MSXPro™ | RapidConnect™ | TINYOPTO™ | |
| Across the board. Around the world.™ | | µSerDes™ | TruTranslation™ | |
| The Power Franchise® | | ScalarPump™ | UHC™ | |
| Programmable Active Droop™ | | | | |

DISCLAIMER

FAIRCHILD SEMICONDUCTOR RESERVES THE RIGHT TO MAKE CHANGES WITHOUT FURTHER NOTICE TO ANY PRODUCTS HEREIN TO IMPROVE RELIABILITY, FUNCTION OR DESIGN. FAIRCHILD DOES NOT ASSUME ANY LIABILITY ARISING OUT OF THE APPLICATION OR USE OF ANY PRODUCT OR CIRCUIT DESCRIBED HEREIN; NEITHER DOES IT CONVEY ANY LICENSE UNDER ITS PATENT RIGHTS, NOR THE RIGHTS OF OTHERS. THESE SPECIFICATIONS DO NOT EXPAND THE TERMS OF FAIRCHILD'S WORLDWIDE TERMS AND CONDITIONS, SPECIFICALLY THE WARRANTY THEREIN, WHICH COVERS THESE PRODUCTS.

LIFE SUPPORT POLICY

FAIRCHILD'S PRODUCTS ARE NOT AUTHORIZED FOR USE AS CRITICAL COMPONENTS IN LIFE SUPPORT DEVICES OR SYSTEMS WITHOUT THE EXPRESS WRITTEN APPROVAL OF FAIRCHILD SEMICONDUCTOR CORPORATION.

As used herein:

1. Life support devices or systems are devices or systems which, (a) are intended for surgical implant into the body, or (b) support or sustain life, or (c) whose failure to perform when properly used in accordance with instructions for use provided in the labeling, can be reasonably expected to result in significant injury to the user.
2. A critical component is any component of a life support device or system whose failure to perform can be reasonably expected to cause the failure of the life support device or system, or to affect its safety or effectiveness.

PRODUCT STATUS DEFINITIONS

Definition of Terms

| Datasheet Identification | Product Status | Definition |
|--------------------------|------------------------|---|
| Advance Information | Formative or In Design | This datasheet contains the design specifications for product development. Specifications may change in any manner without notice. |
| Preliminary | First Production | This datasheet contains preliminary data, and supplementary data will be published at a later date. Fairchild Semiconductor reserves the right to make changes at any time without notice in order to improve design. |
| No Identification Needed | Full Production | This datasheet contains final specifications. Fairchild Semiconductor reserves the right to make changes at any time without notice in order to improve design. |
| Obsolete | Not In Production | This datasheet contains specifications on a product that has been discontinued by Fairchild semiconductor. The datasheet is printed for reference information only. |